



moving forward in every field

LANGUE/LANGUAGE • FR/EN

MERLO

▶▶ PIÈCES POUR CHARGEURS TÉLÉSCOPIQUES/ TELEHANDLER PARTS

Catalogue - Première publication 2007

Catalogue - First published 2007

www.bepcoparts.com

Member of **TVH** 

■ À PROPOS DE BEPCO

Le groupe Bepco est un leader mondial dans la fourniture de pièces de rechange, accessoires pour tracteurs et pièces détachées pour machines agricoles.

Avec plus de 360 employés, le groupe Bepco a des filiales en Belgique, France, Pays-Bas, Allemagne, Espagne et Angleterre. Nous sommes aussi présents en Australie, Nouvelle Zélande, Afrique du sud et au Brésil.

Le groupe Bepco est une société mondiale avec des clients dans plus de 100 pays à travers le monde, les ventes hors Europe contribuent à plus d'un tiers du chiffre d'affaires.

Nous proposons à notre réseau de distributeurs et revendeurs :

- ▶ Des fournisseurs d'équipements d'origine et d'autres marques reconnues
- ▶ Plus de 20 000 m² de surface de stockage
- ▶ Plus de 80 000 références en stock
- ▶ Des connaissances techniques d'experts de l'industrie
- ▶ Une expédition le jour même pour une livraison le jour suivant

Le groupe Bepco fait partie du groupe TVH, fournisseur de pièces et accessoires de qualité pour le matériel de manutention, les véhicules industriels et l'équipement agricole.

ABOUT BEPCO

Bepco Group is a worldwide leading supplier of parts and accessories for agricultural tractors and machinery.

With over 360 employees Bepco Group has subsidiaries in Belgium, Netherlands, France, Germany, Spain and UK and is also present in Australia, New Zealand, South Africa and Brazil.

Bepco Group is a truly global company with customers in over 100 countries worldwide and sales outside Europe contributing to over a third of revenues.



We offer our network of distributors and dealers :

- ▶▶ Original Equipment Supplier and other industry leading brands
- ▶▶ More than 20,000 m² of warehousing
- ▶▶ More than 80,000 stock items
- ▶▶ Technological knowledge from industry experts
- ▶▶ Same day shipment, next day delivery in many markets

Bepco Group is also a member of TVH, the all-round supplier of quality parts and accessories for material handling, industrial vehicles and agricultural equipment.

MERLO PARTS

REFROIDISSEUR D'HUILE - OIL COOLER - ÖLKÜLHER - OLIE KOELER - REFRIGERADOR ACEITE

	N° de construction <i>Build number</i>	Ref.	
A4.236	LD, LJ, LH	42/6097-7 (P2486A219)	
1004.4	AA, AB, AE, AJ, AK, AQ, AR, AS		

Les références des pièces sont indicatives.
Nos pièces ne sont pas d'origine.

*Part numbers are quoted for reference purposes only.
Our parts and accessories are not original.*



Index

Index

■ Accessoires réservoir	19	■ Accelerator cable	22
■ Alternateurs	20	■ Air-conditioning	22
■ Avertisseurs sonore	13	■ Alternators	20
■ Batterie	20	■ Battery	20
■ Bougie de préchauffage	6	■ Brakes	15
■ Câble d'accélérateur	22	■ Cab Filters	11
■ Ceintures de sécurité	25	■ Cross references	29
■ Climatisation	22	■ Filters	9-11
■ Contacteurs	14	■ Front axle 4WD	17
■ Courroies	8	■ Fuel pre-cleaner	11
■ Démarreurs	21	■ Fuel pump	6
■ Direction	16	■ Fuel tank accessories	19
■ Durites	7, 8	■ Gas struts	24
■ Éclairage	12, 13	■ Glass	27, 28
■ Essuie-glace	23	■ Handle & hinge	24
■ Filtres	9-11	■ Heater plug	6
■ Filtres de cabines	11	■ Horns	13
■ Freins	15	■ Hoses	7, 8
■ Gaine métallique	19	■ Hydraulic cylinders & wear parts	18
■ Index des références	30	■ Hydraulic pumps	19
■ Moteur d'essuie-glace	23	■ Lighting	12, 13
■ Peintures	25	■ Metalic armour guard	19
■ Poignée et charnières	24	■ Mirrors	24
■ Pompe d'alimentation	6	■ Paints	25
■ Pompes à eau	6	■ Radiators	7
■ Pompes hydrauliques	19	■ Reference index	30
■ Pont avant 4RM	17	■ Seat	25, 26
■ Préfiltres à gasoil	11	■ Seat belt	25
■ Radiateurs	7	■ Starters	21
■ Références interchangeables	29	■ Steering	16
■ Rétroviseurs	24	■ Switches	14
■ Siège	25, 26		

■ Thermostats	7	■ <i>Thermostats</i>	7
■ Types & motorisation.	5	■ <i>Types & motorization</i>	5
■ Vérins & pièces d'usure	18	■ <i>V' Belt</i>	8
■ Vérins à gaz	24	■ <i>Water pumps</i>	6
■ Vitrierie	27, 28	■ <i>Wiper</i>	23
		■ <i>Wiper motor</i>	23

TYPES & MOTORISATION TYPES & MOTORIZATION

Type d'engin Mach. types	Moteur Engine	Type Type	Modèle Model
P.25			
P25-7			
P.26			
P26 EVS	Perkins	1004-4	
P26-6EVT	Perkins	1004-4TE	AK81029
P26-6 LP	Perkins	1104C-44	
P26-6 SP	Perkins	1104C-44	
P26-6SPT	Perkins	1104C-44T	
P26-6 KT	Perkins	1104C-44T	
P.27			
P27-7			
P.28			
P28-7 EVS	Perkins	1004-4	
P28-7 EVT	Perkins	1004.4T	
P28-7KT	Perkins	1104C-44T	
P28-9EVS	Perkins	1004-4	
P.30			
P30-7			
P30-7EVX	Perkins	1004-4T	AA.80576
P30-7EVT	Perkins	1004-4	AA.80576
P30-7EVT	Perkins	1004-4T	AB.80577
P30-13XS	Perkins	1004-4T	AA
P30-13EVS	Perkins	1004-4T	AA.80576
P.32			
P32-7EVT	Perkins	1004-4T	
P.33			
P33-7 KT	Perkins	1104C-44T	RG.81391
P.34			
P34-7 PLUS	Deutz 4 cyl. Turbo 102cv		
P34-7 Top	Deutz 4 cyl. Turbo 102cv		
P34-10Plus	Deutz 4 cyl. Turbo 102cv		
P34-10Top	Deutz 4 cyl. Turbo 102cv		
P.36			
P36-7 Plus	Deutz 4 cyl. Turbo 102cv		
P36-7 Top	Deutz 4 cyl. Turbo 102cv		
P36-10 Plus	Deutz 4 cyl. Turbo 102cv		
P36-10 Top	Deutz 4 cyl. Turbo 102cv		
P.37			
P37-10	Deutz 4 Cyl. Turbo Aftercooler 140cv		
P37-10 Top	Deutz 4 Cyl. Turbo Aftercooler 140cv		
P37-12	Perkins	1104C-44	
P37-12 Plus	Perkins	1104C-44T	

Type d'engin Mach. types	Moteur Engine	Type Type	Modèle Model
P.38			
P38-10	Deutz 4 Cyl. Turbo Aftercooler 140cv		
P38-10 Top	Deutz 4 Cyl. Turbo Aftercooler 140cv		
P38-12	Perkins	1104C-44	
P38-12 Plus	Perkins	1104C-44T	
P38-13	Perkins		
P38-13 Plus	Perkins	1104C-44T	
P38-14	Perkins	1104C-44	
P38-14 Plus	Perkins	1104C-44T	
P.40			
P40-7	Deutz 4 Cyl. Turbo Aftercooler 140cv		
P40.7 Top	Deutz 4 Cyl. Turbo Aftercooler 140cv		
P40-14 K	Deutz 4 cyl. Turbo 102cv		
P40-16 KS	Deutz 4 cyl. Turbo 102cv		
P40-17 K	Deutz 4 cyl. Turbo 102cv		
P.41			
P41-7	Deutz 4 Cyl. Turbo Aftercooler 140cv		
P41-7 Top	Deutz 4 Cyl. Turbo Aftercooler 140cv		
P.45			
P45-18 HM	Deutz 6 Cyl. Turbo intercooler 145 cv		
P.60			
P60-10K	Perkins	1104C-44T	
P.72			
P72-10 K	Perkins	1104C-44T	
P.80			
P80-9 HM	Deutz 6 Cyl. Turbo intercooler 145 cv		
P.101			
P101-10 HM	Deutz 6 Cyl. Turbo intercooler 145 cv		
MULTI FARMER			
30-6 Class.	Deutz	BF4M2012	
30-6 Top	Deutz	BF4M2012	

POMPE D'ALIMENTATION FUEL PUMP

Types d'engins Machines types	Moteurs Engine	Pompes Pumps	Kit de réparation Repair kit
P28-7EVS, P28-9EVS, P28-7EVT, P32-7EVT P.25 à P 33 suivant montage / some fitting	1004-4 1004-4T	42/100-93 (ULPK0034, ULPK0005)	42/101-17 (ULPR0005)



BOUGIE DE PRÉCHAUFFAGE HEATER PLUG

Types d'engins Machines types	Moteurs Engine	OEM	Réf. Ref.
P28-7EVS, P28-9EVS, P28-7EVT, P32-7EVT, P 33-7KT & autres Types / & other types	4.236, 1004-4 1004-4T	2666108	42/60-24

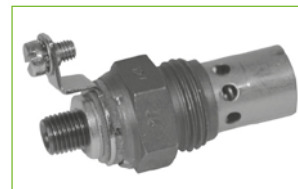

POMPES À EAU WATER PUMPS

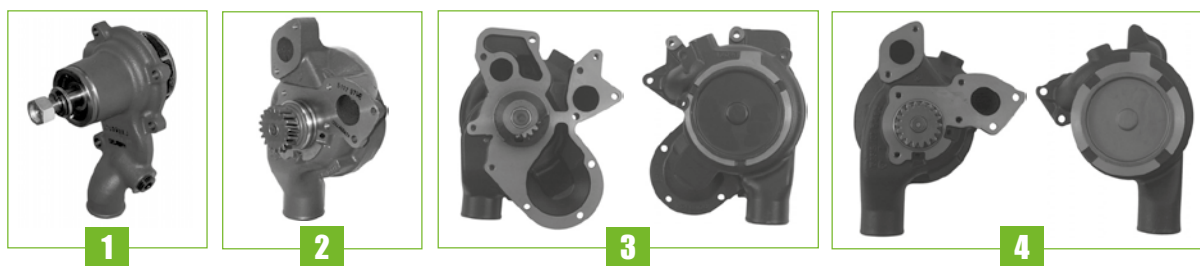

Pompes Pumps	OEM	Moteurs Engine	Fig.
42/130-214	U5MW0104	4.236	1
42/130-248	U5MW0157, U5MW0092	1004-4, 1004-4T	2
42/130-194	U5MW0178, U5MW0189, U5MW0192	1004-4, 1004-4T	3
42/130-193	U5MW0159, U5MW0160	1006-6	4

THERMOSTATS THERMOSTATS

Types d'engins Machines types	Moteurs Engine	Réf. Ref.	Fig.
Perkins	1004-4, 1004-4T	42/143-88 (2485C025)	1
	1004-4, 1004-4T, 4.236	42/143-43 (2485613)	2

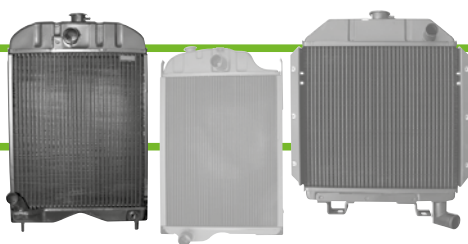

RADIATEURS RADIATORS

Types d'engins Machines types	Réf. Ref.	OEM
P28-7EVS, P28-9EVS, P28-7EVT, P32-7EVT	42/150-159	M032327
P26.6EVT, P26-6SPT, P28.7EVT, P28-7KT, P33-7KT	42/150-164	
27-7, 32-7EVS	42/150-163	

DURITES HOSES



Types d'engins Machines types	Moteurs Engine	Durite supérieure Top hose	Fig.	Durite inférieure Bottom hose	Fig.
P28-7EVS, P28-9EVS, P28-7EVT, P32-7EVT	1004-4 1004-4T	42/153-194 (M032934)	1	42/154-194 (M030030)	2

DURITES DE REFROIDISSEMENT HOSES

Moteurs Engine	Réf. Ref.	Mesures Sizes	Description
4.236 AT.4.236 1004-4 1004-T 1004TI	70/tub 1220	20 x 25mm	Longueur 1m utilisable en coude et contre coudé <i>Length 1 m foldable on both side</i>
	70/tub 1225	25 x 31mm	
	70/tub 1231	31.5 x 36mm	
	70/tub 1233	33,5 x 38mm	
	70/tub 1237	37 x 44mm	
	70/tub 1244	44 x 48mm	
	70/tub 1248	48 x 55mm	
	70/tub 1255	55 x 65mm	
	70/tub 1265	65 x 75mm	
70/tub 1280	80 x 88mm		

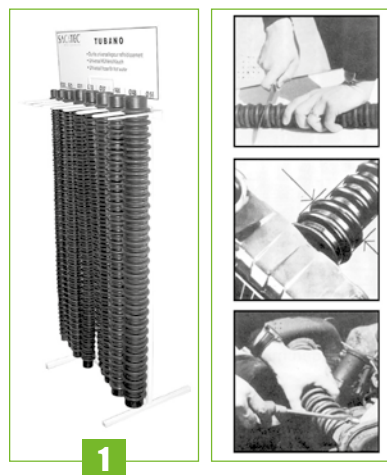

COURROIES V' BELT

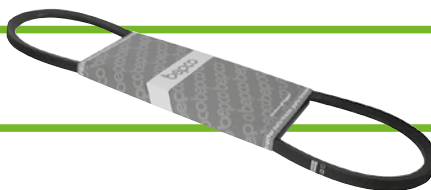

Types d'engins Machines types	Moteurs Engine	Réf. Ref.	OEM	Mesures Sizes
Suivant montage / some fitting	1004-4, 1004-4T	42/144-385 (A)	2614B668	13 x 1490 LA
Multifamer 30-6 classique, 30-6 Top	Ventilateur/ <i>Fan blade</i>	42/144-386	D00079, 01180848	13 x 1000
	Alternateur/ <i>Alternator</i>	42/144-387	D00080, 01179474	10 x 1000
multi farmer 30-6 Class. 30-6 Top Motorisation Deutz engine BF4M2012 modèle Cabine KT / <i>KT cab model</i>	-	42/144-388	M046581	13 x 1000

A: Paire de courroies crantées / *Pair of raw edge cogged belts*

FILTRES
FILTERS



Types d'engins Machines types	Air		Huile Oil	Combustible Fuel
	Ext. / Out.	Int. / Inn.		
	1		2	3
Moteur Deutz / Deutz engine - F4L1011F				
	60/161-45 (04384102, D00033)	60/162-119 (D00032)	60/97-39 (D00053, 01174421)	60/111-56 (3M01586, 01174423, 01180597)
Multifamer 30-6 class. 30-6 Top : Moteur Deutz / Deutz engine - BF4M2012				
	60/161-203 (M049504)	60/162-203 (M049505)	60/97-39 (D00053, 01174421)	60/111-56 (3M01586, 01174423, 01180597)
Roto 6 cylindres Deutz / Roto 6 cylinders Deutz - BF6M1012				
P30.7EVX, P28.7EVT, P35.9EVS, P35.13EVS	60/161-176 (D00043)	60/162-176 (D00044)	60/97-39 (D00053, 01174421)	60/111-96 (01180596)
Filtre moteurs Perkins/ Perkins engine filter Type de moteur / Engine type : 4,236				
	60/161-38 (P00274, P00503)	60/162-113 (P00275, P00506)	60/97-2 (2654403)	60/111-3 (P00518) repl. Cav 296
Filtre moteurs Perkins/ Perkins engine filter Type de moteur / Engine type : T4,236				
	60/161-38 (P00274, P00503)	60/162-113 (P00275, P00506)	60/97-2 Long/Long (2654403)	60/111-3 (P00518) repl. Cav 296
Filtre moteurs Perkins/ Perkins engine filter Type de moteur / Engine type : 1004-4				
P28-7EVS, P28-9EVS	60/161-38 (P00274, P00503)	60/162-113 (P00275, P00506)	60/97-2 (2654403) AA,AR,AB	60/111-3 (P00518) repl. Cav 296
			60/111-5 (26560017) 7111/296	
Filtre moteurs Perkins/ Perkins engine filter Type de moteur / Engine type : 1004-4T				
P28-7EVT, P32-7EVT	60/161-60 (P00504)	60/162-25 (P00507)	60/97-2 (2654403)	60/111-3 (P00518) repl. Cav 296
				60/111-5 (26560017) 7111/296
				60/111-4 Long/Long Cav 796
Filtre moteurs Perkins/ Perkins engine filter Type de moteur / Engine type : 1104C.44T				
			60/97-100 Cartouche/Cartridge (2644A002, P00691)	
P 33-7KT	60/161-60 (P00504)	60/162-25 (P00507)	60/97-176 À visser/Spin on (2654A002)	60/111-176 (26560201, P00690)

FILTRES FILTERS

4

5

Types d'engins Machines types	Hydraulique Hydraulic	Transmission Transmission
	4	5
Filtre moteurs Perkins / Perkins engine filter		
Type de moteur / Engine type: 1104		
P28-7EVS, P28-9EVS, P28-7EVT, P32-7EVT, P 33-7KT + Roto	60/240-81 (M032320) Retour/Return Cartouche/Cartridge	60/657-3 (M026611) 1 ¹ / ₄ " Rexroth
	60/641-25 (M016561) Asp./Asp. Crépine/Strainer	60/657-8 (M036397) 1 ³ / ₈ " Sauer
P28-7EVS, P28-9EVS, P28-7EVT, P32-7EVT, P 33-7KT	60/240-82 (M026253) Retour/Return À visser/Spin on	
Tous modèles XS / All XS models	60/655-17 (M018223) Retour/Return Cartouche/Cartridge	
Multi farmer 30-6 Class. 30-6 Top	60/657-8 (M036397) À visser/Spin on	
	60/641-25 (M016561) Crépine aspiration Aspiration strainer	
	60/240-81 (M032320) Cartouche / Réservoir supérieur Cartridge / Upper tank	
	60/240-82 (M026253) À visser / Réservoir inférieur Spin on / Lower tank	
Roto 6 cylindres Deutz / Roto 6 cylinders Deutz - BF6M1012		
	60/240-81 (M032320) Cartouche / Réservoir supérieur Cartridge / Upper tank	
	60/240-82 (M026253) À visser / Réservoir inférieur Spin on / Lower tank	
	60/657-8 (M036397) À visser/Spin on	
	60/641-25 (M016561) Crépine aspiration Aspiration strainer	

FILTRES DE CABINES CAB FILTERS

Types d'engins Machines types	Réf. Ref.	OEM	Mesures Sizes	Fig.
P28-7EVS, P28-9EVS, P28-7EVT, P32-7EVT, P 33-7KT + Roto	82/4200-50	M028948	175 x 90 x 90 mm	
Série EV Series (1998⇨)	82/4200-28	M040640	235 x 85 x 48 mm	
	82/4200-37	M045746	435 x 155 x 18 mm	

PRÉFILTRES À GASOIL FUEL PRE-CLEANER



Types d'engins Machines types	Réf. Ref.	OEM	Mesures Sizes	Fig.
Multi-farmer	60/104-4	D0054, 02931168	Ø: 83 mm hauteur / height: 118 mm	

FILTRES FILTERS

Dimensions filtres Filters sizes

Réf. Ref.	Ø x H L x I x H	Filet Thread	Réf. Ref.	Ø x H L x I x H	Filet Thread	Réf. Ref.	Ø x H L x I x H	Filet Thread
60/97-2	93 x 143	3/4" - 16	60/161-38	155 x 305		60/240-81	106 x 190	
60/97-39	93 x 212	1"-12 UNF	60/161-45	165 x 208		60/240-82	138 x 220	2"-11 BSP
60/97-100	73 x 136		60/161-60	154 x 392		60/641-25	53 x 50	
60/97-176	73 x 136		60/161-176	195 x 395		60/655-17	78 x 205	
60/111-3	86 x 72		60/161-203	188 x 395		60/657-3	128 x 180	1 1/4" -11 BSP
60/111-4	84 x 112		60/162-25	86 x 358		60/657-8	98 x 150	1 3/8" -12
60/111-5	86 x 72		60/162-113	105 x 280		82/4200-28	235 x 85 x 48	
60/111-56	76 x 123	M16 x 1.5	60/162-119	75 x 345		82/4200-50	173 x 90 x 49	
60/111-96	78 x 80	M16 x 1.5	60/162-176	106 x 385		82/4200-37	435 x 155 x 18	
60/111-176	75 x 160		60/162-203	106 x 385				

ÉCLAIRAGE LIGHTING

Réf. Ref.	OEM	Description	Fig.	Types d'engins Machines types
Phare avant / Front lamp				
42/189-22	M037027	Phare avant Gauche <i>Left front lamp</i>		25-7, 27-7, 30-7, P28-7EVS, P28-9EVS, P28-7EVT, P32-7EVT & autres modèles / & other models
42/189-23	M037028	Phare avant Droit <i>Right front lamp</i>		
42/189-42	M014643, M035577	Phare avant Gauche <i>Left front lamp</i>		
42/189-43	M014642, M035576	Phare avant droit <i>Right front lamp</i>		
42/1924-1	M026449	Grille / Grid		
42/1919-80	M015401	Verre / Glass		
42/1918-83	M020074	Feux clignotant Droit <i>Right indicator</i>		
42/1918-84	M020075	Feux clignotant Gauche <i>Left indicator</i>		
42/1919-81		Cabochoon feux clignotat D & G <i>Rh. Lh. indicator glass</i>		
42/189-24	042814	Phare avant droit <i>Right front lamp</i>		KT, SP Models
42/189-25	042815	Phare avant Gauche <i>Left front lamp</i>		
63/1955-472		Ampoule / Bulb H4 - 12V - 55/60W		
42/1918-83	M020074	Feux clignotant Droit <i>Right indicator</i>		
42/1918-84	M020075	Feux clignotant Gauche <i>Left indicator</i>		
42/1919-81		Cabochoon feux clignotat D & G <i>Rh. Lh. indicator glass</i>		

ÉCLAIRAGE LIGHTING







Réf. Ref.	OEM	Description	Fig.	Types d'engins Machines types
Phares de travail / Worklamp				
42/1931-19		Phare de travail haut de cabine <i>Upper cab worklamp</i>		Modèles EV, KT, SP Models
63/1931-27	M041918	Phare de travail / <i>Worklamp</i>		Multifamer 30-6 class. 30-6 Top & autres modèles cabine série KT & other cab models KT series
Feux arrière / Rear lamp				
42/1912-34	M037026	Feux Arrière droit <i>Right rear lamp</i>		25-7, 27-7, 30-7, P28-7EVS, P28-9EVS, P28-7EVT, P32-7EVT & autres modèles / & other models
42/1912-35	M037025	Feux Arrière Gauche <i>Left rear lamp</i>		
42/1912-141	M035578, M032993	Feux Arrière Gauche & Droit <i>Right and left rear lamp</i>		Autres Modèles / <i>Other models</i>
42/1913-136		Cabochon Gauche & Droit <i>Right and left glass</i>		

AVERTISSEURS SONORE HORNS





Types d'engins Machines types	Réf. Ref.	OEM	Description	Fig.
25-7, 27-7, 30-7, P28-7EVS, P28-9EVS, P28-7EVT, P32-7EVT & autres modèles / & other models	63/1995-5		Klaxon / <i>Horn</i>	1
25-7, 27-7, 30-7, P28-7EVS, P28-9EVS, P28-7EVT, P32-7EVT & autres modèles / & other models Multifamer 30-6 class. 30-6 Top & autres modèles KT / & other models KT	63/1921-1	M032904	Alarme de recul <i>Reversing horn</i>	2

CONTACTEURS SWITCHES

Types d'engins Machines types	Réf. Ref.	Fig.
25-7, 27-7, 30-7, P28-7EVS, P28-9EVS, P28-7EVT, P32-7EVT & autres modèles / & other models	42/962-53 (M037828) Sélecteur de flèche avec clé <i>Boom selector switch with key</i> CEMA P9PPDNVO	
	42/962-55 (M037825) Mano contact frein à main <i>Hand brake warning switch</i> CEMA P9P11VN	
	42/962-56 (M037826) Contacteur d'annulation de sécurité <i>Safety removal switch</i> CEMA P9B20VN	
	42/962-57 (M037605) Contacteur de sélecteur de vitesse <i>Speed selection switch</i> CEMA P9B10VN	
	63/950-93 (P00139) Contacteur de démarrage / Starter switch Perkins 2846130	
	42/962-54 (M032492) Contacteur fin de course / Stroke switch	

CONTACTEURS COMBINÉS COMBINED SWITCHES

Types d'engins Machines types	Réf. Ref.	Fig.
25-7, 27-7, 30-7, P28-7EVS, P28-9EVS, P28-7EVT, P32-7EVT & autres modèles / & other models	42/958-43 (M035367) Contacteur combiné complet <i>Complete combined switch</i> Droit + Gauche / R. + L.	
	42/958-46 (M037848) Contacteur combiné droit <i>Right combined switch</i>	
	42/958-45 (M037847) Combiné gauche <i>Left combined switch</i>	

FREINS BRAKES

Types d'engins Machines types	Maîtres cylindres Master cylinder	Fig.
25-7, 27-7, 30-7, P28-7EVS, P28-9EVS, P28-7EVT, P32-7EVT & autres modèles / & other models	42/410-65 (M014652K) Sans servo frein Without servo brake	1
	42/410-66 (M046338) Avec servo frein With servo brake	2



Types d'engins Machines types	Kit de réparation Repair kit	Fig.
25-7, 27-7, 30-7, P28-7EVS, P28-9EVS, P28-7EVT, P32-7EVT & autres modèles & other models	42/7801-1 (M013525AA) Étrier frein à pied / Foot brake	1
	42/7801-2 (M047378K) Étrier frein de parking / Parking brake	2
Modèles EV Models	42/411-33 (015133AA)	3
Modèles KT, SP Models	42/411-34 (044266)	

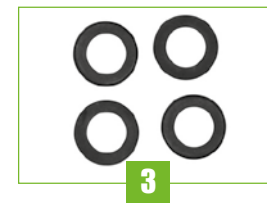
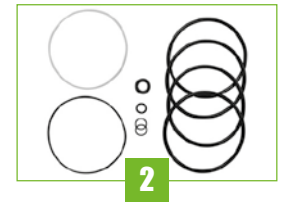





DISQUES ET PLAQUETTES DISC & PADS

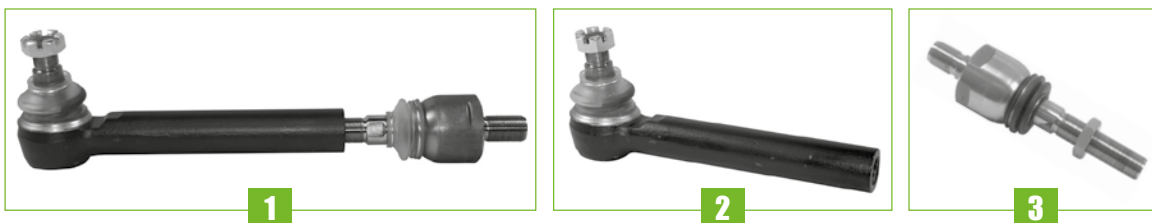

Types d'engins Machines types	Réf. Ref.	OEM	Description	Fig.
25-7, 27-7, 30-7, P28-7EVS, P28-9EVS, P28-7EVT, P32-7EVT & autres modèles / & other models	42/420-11	M021590	Disque de frein / Brake disc	1
	42/412-13	M035498, M049614	Plaquettes de parking / Parking pads Ancien modèles / Old models - Épaisseur / Thickness 12mm	2
	42/412-12	M042194	Plaquettes de parking / Parking pads Nouv. modèles / New models - Épaisseur / Thickness 11mm	
	42/412-14	M046917 M025964	Plaquettes de frein à pied / Foot brake pads Ancien modèles / Old models - Épaisseur / Thickness 16.7mm	
	42/412-11	M042970, M042994	Plaquettes de frein à pied / Foot brake pads Nouv. modèles / New models - Épaisseur / Thickness 17.5mm	
Multifamer 30-6 classique / classical, 30-6 Top	42/412-14	M046917 M025964	Plaquettes de frein à pied / Foot brake pads	

ROTULES & TIRANTS DE DIRECTION TIE RODS & SOCKETS



Types d'engins Machines types	Réf. Ref.	OEM	Description				Fig.
25-7, 27-7, 30-7, P28-7EVS, P28-9EVS, P28-7EVT, P32-7EVT & autres modèles / & other models	42/490-1	M046738	Tirant + accouplement Tie-rod + coupling	M22 x 1.5 - Dr. / RH.	390	23.5x26	1
	42/495-168	M039681	Tirant / Tie-rod	F 22 x 1.5 - Dr. / RH.	240	23.5x26	2
	42/497-169	M028173	Accouplement Coupling	M22 x 1.5 / M 22 x 1.5 - Dr. / RH.	210	-	3
26-6, 30-7 & nouveaux modèles / & new models	42/490-2	M046740	Tirant + accouplement Tie-rod + coupling	M 22 x 1.5 - Dr. / RH.	290	23.5x26	1
	42/495-169	M040061	Tirant / Tie-rod	F 22 x 1.5 - Dr. / RH.	140	23.5x26	2
	42/497-169	M028173	Accouplement Coupling	M22 x 1.5 / M 22 x 1.5 - Dr. / RH.	210	-	3
EV, KT, SP Models	42/490-4	M024409	Tirant + accouplement Tie-rod + coupling	M 22 x 1.5 - Dr. / RH.	290	23.5x26	1
	42/495-269	M802542	Tirant / Tie-rod	F 22 x 1.5 - Dr. / RH.	140	23.5x26	2
	42/497-224	M802917	Accouplement Coupling	M22 x 1.5 / M 22 x 1.5 - Dr. / RH.	210	-	3

DIRECTION HYDRAULIQUE HYDRAULIC STEERING

Types d'engins Machines types	Réf. Ref.	OEM	Description
25-7, 27-7, 30-7, P28-7EVS, P28-9EVS, P28-7EVT, P32-7EVT & autres modèles / & other models	42/585-46	M036947	Kit réparation vérin hydraulique Repair kit hydraulic cylinder



PONT AVANT 4RM FRONT AXLE 4WD

CROISILLONS UNIVERSAL JOINT

Types d'engins Machines types	Réf. Ref.	OEM	Description	Fig.
Tous type suivant montage All models some fitting	42/6403-35	M024972	Ø 35 - L.97mm	1
Multifamer 30-6 classique, 30-6 Top	42/6403-97	M047499	Ø 35 - L.93mm	2

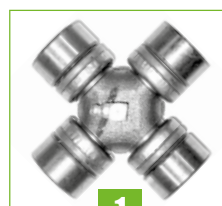

1

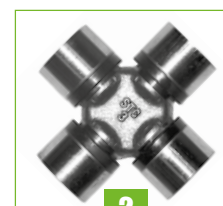

2

JEUX DE BAGUES RINGS SET

Types d'engins Machines types	Jeu de joints Seals set	Jeu de bagues Rings set
	1	2
Modèles EV, KT, SP Models	42/6417-11 (042077)	42/6450-75 (A) (027012 + 036484) 42/6450-76 (B) (024958 + 024986 + 034483)

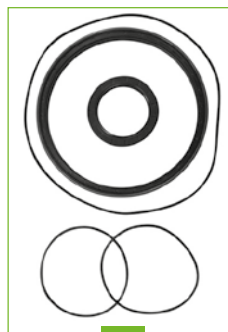

1

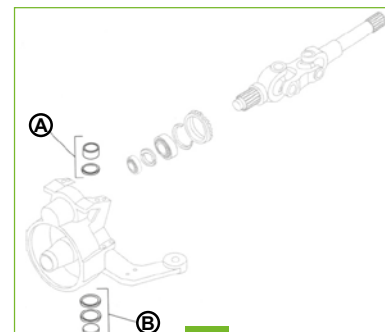

2

VÉRINS & PIÈCES D'USURE

HYDRAULIC CYLINDERS & WEAR PARTS



Types d'engins Machines types	Réf. Ref.	OEM	Description
25-7, 27-7, 30-7, P28-7EVS, P28-9EVS, P28-7EVT, P32-7EVT & autres modèles / & other models	42/7611-14	M032128	Valve de sécurité (vérin principal). Safety valve (main cylinder).
	42/7611-15	M029128	Valve de sécurité (vérin de flèche télescopique). Safety valve (boom cylinder).
	42/7611-16	M036548	Valve de sécurité vérin de parallélogramme. Safety valve (stabiliser cylinder).
	42/7611-17	M031860	Valve de sécurité vérin d'outils (bout de flèche). Safety valve (tool cylinder).
	42/775-7	M029403	Bague tête de vérin (coté tige) (vérin principal). Cylinder head oil seal (main cylinder).
	42/775-8	M036505	Bague tête de vérin (coté tige) (bout de flèche). Cylinder head oil seal (boom cylinder).
	42/775-9	M029404	Bague pied de vérin (vérin principal). Cylinder foot oil seal (main cylinder).
	42/775-10	M031399	Kit réparation vérin de verrouillage (d'outils). Repair kit (tool cylinder).
	42/775-9	M029404	Kit 2 bagues pied de vérin (bout de flèche). Repair kit cylinder head oil seal (boom cylinder).
	42/775-11	M023040	Kit réparation vérin montée (vérin principal). Repair kit (lift main cylinder).
	42/775-12	M029262	Kit réparation vérin d'extention (vérin de flèche télescopique). Repair kit extension cylinder (boom cylinder).
	42/775-13	M027091	Kit réparation vérin de parallélogramme. Repair kit (stabiliser cylinder).
	42/775-11	M023040	Kit réparation vérin d'outil (bout de flèche). Repair kit (tool cylinder).
EV, KT, SP Models	42/705-4	030448	Bague d'axe d'articulation inf. de la flèche. Inferior boom axle bush.
	42/705-5	029368	Bague d'axe d'articulation inf. Inferior main axle bush.
	42/704-22	036489	Axe d'articulation sup. Superior main axle bush.
	42/704-23	033916	Axe d'articulation inf. Inferior main axle.
	42/704-24	029412	Axe de vérin de poussée Push cylinder axle.

CALE DE COULISSEMENT

SLIDING SHAFT KEY

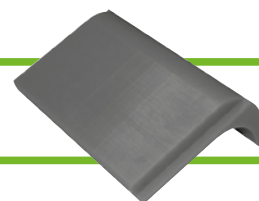

Types d'engins Machines types	Réf. Ref.	OEM	Description
25-7, 27-7, 30-7, P28-7EVS, P28-9EVS, P28-7EVT, P32-7EVT & autres modèles / & other models	42/775-14	M011456BA	Cale de coulissement flèche (flèche fixe). Boom sliding key (fixed boom).
	42/775-15	M022919	Cale de coulissement sur flèche télescopique. Boom sliding key (telescopic boom).

GAINÉ MÉTALLIQUE (AU MÈTRE) METALIC ARMOUR GUARD (BY METER)

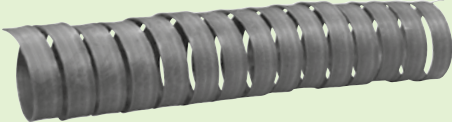
Réf. Ref.	Ø int. Ø Inner	Largeur Width	Épaisseur Thickness	Fig.
69/9410-20	45 mm	12.5 mm	1 mm	

POMPES HYDRAULIQUES HYDRAULIC PUMPS

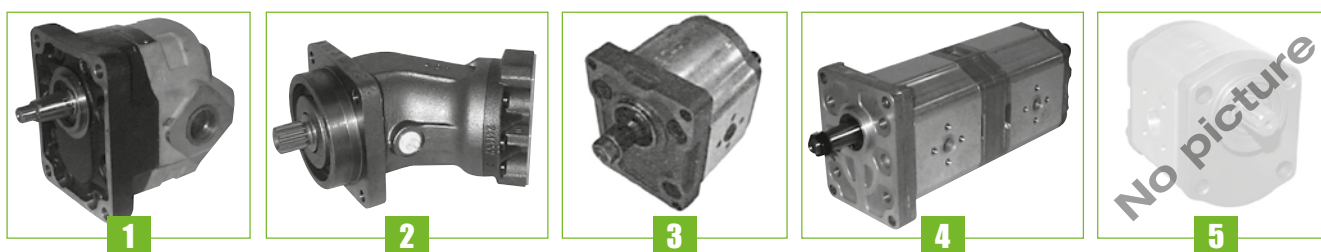





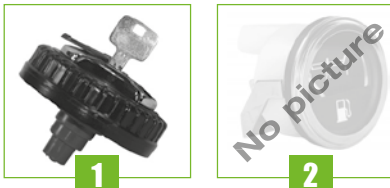

Types d'engins Machines types	Réf. Ref.	Description	Fig.
P26.6LPT, P26.6SPT, P26.6EVT, P28.7EVT, P30.7	42/566-300	Pompe de levage / Lifting pump	1
P25.7	42/566-301	Moteur translation / Translation motor	2
P25.7, P30.7	42/566-302	Pompe de levage / Lifting pump	3
P27	42/566-303	Pompe de levage / Lifting pump	
P37XS, P359XS	42/566-304	Pompe de levage / Lifting pump	
P20.6	42/566-305	Pompe de levage / Lifting pump	4
P23.6	42/566-355	Pompe hydraulique / Hydraulic pump	5

ACCESSOIRES DE RÉSERVOIR FUEL TANK ACCESSORIES

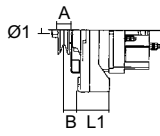
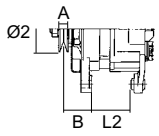
Types d'engins Machines types	Réf. Ref.	Description	Fig.
P28-7EVS, P28-9EVS, P28-7EVT, P32-7EVT	42/105-40 (M044196)	Bouchon de réservoir Fuel tank cap	1
	42/171-7 (M027045)	Jauge à Gasoil Fuel dipstick	2

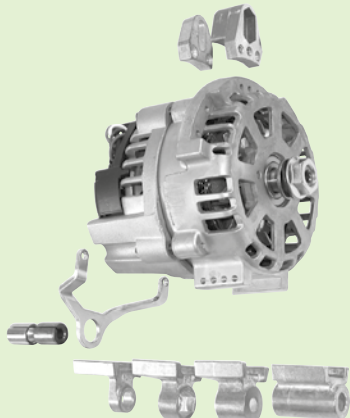

ALTERNATEURS ALTERNATORS

Réf. Ref.	Moteurs Engine	Description										
62/920-108 (71420400) 12v - 70Amp.	Perkins	2871A163 23737R	 ↻ <table border="1"> <tr><td>Ø1</td><td>A</td><td>B</td><td>L2</td></tr> <tr><td>17</td><td></td><td></td><td>82</td></tr> </table>	Ø1	A	B	L2	17			82	
Ø1	A	B	L2									
17			82									
62/920-101 12V - 70Amp.	Perkins	2871A137	 ↻ <table border="1"> <tr><td>Ø1</td><td>A</td><td>B</td><td>L2</td></tr> <tr><td>17</td><td></td><td></td><td>82</td></tr> </table>	Ø1	A	B	L2	17			82	
Ø1	A	B	L2									
17			82									
62/920-102 12V - 80Amp.	Deutz	-	 ↻ <table border="1"> <tr><td>Ø2</td><td>A</td><td>B</td><td>L1</td></tr> <tr><td>70</td><td>10</td><td>21</td><td>56</td></tr> </table>	Ø2	A	B	L1	70	10	21	56	
Ø2	A	B	L1									
70	10	21	56									
Alternateur universel / Universal alternator												
62/920-152KT 12V - 120Amp.	Deutz F4 L 1011F	Gauche ou droit Left or right Pièces interchangeables avec BOSCH et Delco Remy Interchangeable parts with BOSCH and Delco Remy										

BATTERIE BATTERY

Types d'engins Machines types	Moteurs Engine	OEM	Réf. Ref.
P28-7EVS, P28-9EVS, P28-7EVT, P32-7EVT, P 33-7KT & autres Types / & other types	4.236, 1004-4 1004-4T	M032591	82/9202-951



DÉMARREURS STARTERS

Ref. Ref.	OEM	Type	A x B 	Z 	
62/930-80 1004-4, 1004-4T	2873A101, 2873A103, 2873A107	12V - 2.8 Kw Montage Gauche / <i>Left fitting</i>	3x127 	10Z	238
62/930-5 1104C.44, 1104C.44T	2873B072	12V - 3.5 Kw Montage Gauche / <i>Left fitting</i>	3x127 	10Z	250
62/930-200 ISKRA 62/930-223 MAGNETON		12V - 3.0 Kw Montage Gauche / <i>Left fitting</i> Avec réducteur / <i>With reducer</i>	3x127 	10Z	204
62/930-38 1004-4, 1004-4T	2873A102, 2873B056, 2873B071	12V - 2.8 Kw Montage droit / <i>Right fitting</i>	3x127 	10Z	237
62/930-181 1004-4, 1004-4T	2873K404	12V - 4, 2 Kw avec reducteur / <i>with reducer</i> montage droit / <i>right fitting</i>	3x127 	10Z	225
62/930-205 Deutz F4L1011		12V - 2.7 Kw	2x105 	11Z	220
62/930-185 Deutz F4L1011		12V - 2.8 Kw avec reducteur / <i>with reducer</i>	2x105 	11Z	220

CÂBLE D'ACCÉLÉRATEUR ACCELERATOR CABLE



1



2

Types d'engins Machines types	Remarques Observations	Réf. Ref.	Fig.
25-7, 27-7, 30-7, P28-7EVS, P28-9EVS, P28-7EVT, P32-7EVT & autres modèles SP / & Other models SP	Avec rotule / With tie rod	42/108-74 (M048541)	1
	Sans rotule / Without tie rod	42/108-75 (M032621)	2

CLIMATISATION AIR-CONDITIONING



1



2



3

Types d'engins Machines types	Réf. Ref.	OEM	Fig.
Compresseur / Compressor			
multi farmer 30-6 Classique, 30-6 Top & modèle Cabine type KT / & other cab KT type	82/9202-194	M047254	1
Courroie / Fan belt			
multi farmer 30-6 Class. 30-6 Top Motorisation Deutz engine BF4M2012 modèle Cabine KT / KT cab model	42/144-388 13 x 1000	M046581	
Filtre déshydrateur / Dryer			
Toutes série EV équipées EV series	82/9202-426	M040660	2
Filtre à air / Air filter			
	82/4200-131 410 X 155 X 2	M051480	3

ESSUIE-GLACE WIPER



Types d'engins Machines types	Desc.	Balais Brushes	Bras Arms
Cabine type KT / KT cab type multi farmer 30-6 Class. 30-6 Top	Avant Front	42/1987-21 (M045720) 510mm	42/1985-9 (A) (M045719) Avec lave glace / With windscreen washer
	Arrière Rear	42/1987-23 (M045714) 305mm	42/1985-10 (A) (M045716) Avec lave glace / With windscreen washer
25-7, 27-7, 30-7, P28-7EVS, P28-9EVS, P28-7EVT, P32-7EVT & autres modèles SP / & other SP models	Avant Front	42/1987-24 (M032487) 610mm	42/1985-11 (B) (M021841) 400⇒500mm
	Arrière Rear	42/1987-26 (M021842, M0261832) 400mm	42/1985-12 (B) (M022433) 300⇒400mm

MOTEUR D'ESSUIE-GLACE WIPER MOTOR

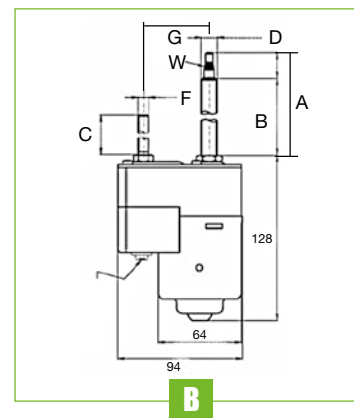
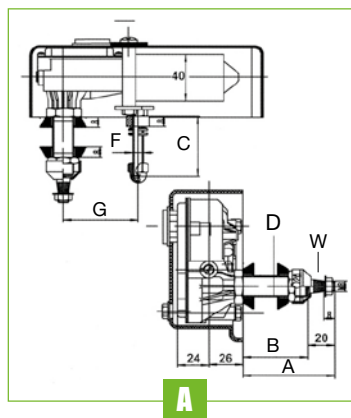

Réf. Ref.	Volt.	Rotation Rotation	Vitesse Speed	A (mm)	B (mm)	C (mm)	D	F	G (mm)	W (Ømm)	Type Type	Fig.	
42/1980-59 (M045718)	85°	12	G. - LH.	-	1	53	33	16	M16 x 1	M8	57	A10 x M8	A
42/1980-60 (M045715)	110°	12	G. - LH.	v	1	53	33	16	M16 x 1	M8	57	A10 x M8	A
42/1980-61 (M022683)	-	12	-	-	1	38	30	16	M12 x 1	M8	50	A8 x M6	B
42/1980-62 (M022684)	-	12	-	v	1	38	30	16	M12 x 1	M8	50	A8 x M6	B

VÉRINS À GAZ GAS STRUTS



Types d'engins Machines types	Réf. Ref.	Mesures Sizes	OEM	Description
multi farmer 30-6 Classique, 30-6 Top	42/870-105	350mm - 50N	M048084	Vérin Glace Ar - Rear window
EV, KT, SP Models	42/870-106	450mm - 740N	024263	Vérin à gaz - Gas struts

POIGNÉE DE VITRE, CHARNIÈRE ET POIGNÉE DE PORTE GLASS HANDLE, HINGE & DOOR HANDLE



Types d'engins Machines types	Réf. Ref.	OEM	Description	Fig.
25-7, 27-7, 30-7, P28-7EVS, P28-9EVS, P28-7EVT, P32-7EVT & autres modèles SP / & Other models SP multi farmer 30-6 Class. 30-6 Top	42/4170-137	M034189	Poignée de vitre latérale Side glass handle	1
multi farmer 30-6 Classique, 30-6 Top & autres modèle Série KT / & Other models KT	42/4090-6	M047916	Poignée de vitre Av/Ar - Sur Vitre Front/rear window handle - On window	2
	42/4090-7	M047956	Charnière de vitre arrière - Sur cabine Rear window hinge - On cab	3
25-7, 27-7, 30-7, P28-7EVS, P28-9EVS, P28-7EVT, P32-7EVT & autres modèles SP / & Other models SP	42/4090-8	M021192	Charnière de vitre arrière Rear window hinge	4
25-7, 27-7, 30-7, P28-7EVS, P28-9EVS, P28-7EVT, P32-7EVT & autres modèles SP / & Other models SP multi farmer 30-6 Class. 30-6 Top	42/4170-138	M032495	Poignée de porte intérieure / Inner door handle	5
	42/4170-68	M032494	Poignée de porte extérieure / Exterior door handle	6

RÉTROVISEURS & SUPPORTS MIRRORS & BRACKETS



Types d'engins Machines types	Réf. Ref.	OEM	Description	Remarques Observations	Fig.
25-7, 27-7, 30-7, P28-7EVS, P28-9EVS, P28-7EVT, P32-7EVT & autres modèles KT & SP / & Other models KT & SP multi farmer 30-6 Class. 30-6 Top	70/4172-52	M032887	Cabine / Cab Support / Bracket	230x175mm Plat / Flat	1
25-7, 27-7, 30-7, P28-7EVS, P28-9EVS, P28-7EVT, P32-7EVT & autres modèles KT & SP / & Other models KT & SP	70/4172-62	M042848	Aile / Wing Rétroviser / Mirrors	360x210mm Bombé / Convex	2
25-7, 27-7, 30-7, P28-7EVS, P28-9EVS, P28-7EVT, P32-7EVT & autres modèles / & Other models multi farmer 30-6 Class. 30-6 Top	70/4172-54	M032888	Support rétroviser / Mirror bracket Coté gauche / left side		3
	70/4172-53		Support rétroviser / Mirror bracket Coté droit / right side		

PEINTURES PAINTS

Teinte Colour	1L	5L	Spray
Vert merlo Merlo green	64/3102-411	64/3102-412	64/3102-413





LAQUE AMERICAINE

La meilleure peinture du marché
The best paint on the market

Plus de 2000 nuances possibles
Possibilité de créer une couleur
suivant échantillon

More than 2000 colors available
Possibility to create a color
from a sample

CEINTURES DE SÉCURITÉ SEAT BELT

Types d'engins Machines types	Réf. Ref.	Fig.
Avec dérouleur / With holder	61/833-2	
Fixe / Fixed	61/833-4	

SIÈGE SEAT

61/830-933



Description

Caractéristiques techniques :

- Sellerie tissu noir
- Appuie tête
- Suspension mécanique réglable (course 100 mm)
- Réglage SIP 35 mm
- Réducteur de course de suspension 70mm
- Glissières (210 mm)
- Dossier inclinable 22° et repliable
- Réglage poids (max.150 kg)
- Réglage lombaire
- Base plane
- Fixations pour ceinture de sécurité

Technical data :

- Black cloth
- Backrest extension
- Adjustable suspension (100mm)
- SIP mechanical adjustment 35 mm
- Suspension travel reducer 70mm
- Slide rails adjustment (210 mm)
- Fully foldable backrest with 22° tilt adj.
- Weight adjustment (max. 150 kg)
- Mechanical lumbar adj.
- Flat mounting plate
- Seat belt fixation points

Options

- 61/834-10: Accoudoirs pivotants
Fold-up armrests

SIÈGE SEAT

61/830-938



Description

Caractéristiques techniques :

- Sellerie velour gris
- Appui-tête réglable
- Suspension mécanique (course 100 mm)
- Réglage SIP 35 mm
- Réducteur de course de suspension 70mm
- Réglage poids (max 150kg)
- Glissières (190 mm)
- Dossier inclinable 32° / repliable
- Réglage lombaire
- Porte-document au dos
- Base plane
- Fixations pour ceinture de sécurité
- Embase pivotante 6°-12°-20°

Technical data :

- Grey velvet
- Adjustable backrest extension
- 100mm mechanical suspension
- SIP mechanical adjustment 35 mm
- Suspension travel reducer 70mm
- Weight adjustment (max. 150 kg)
- Slide rails adjustment (190 mm)
- Fully foldable backrest with 32° tilt adj.
- Mechanical lumbar adj.
- Carry document in back
- Flat mounting plate
- Seat belt fixation points
- Turn table 6°-12°-20°

Options

- 61/834-12: Accoudoirs réglables
Adjustable armrests

61/830-939



Description

Caractéristiques techniques :

- Sellerie velour gris
- Appui-tête réglable
- Suspension pneumatique (course 110 mm)
- Réglage en hauteur (85 mm)
- Réglage poids (max 150Kg)
- Glissières (190 mm)
- Dossier inclinable 32° / repliable
- Réglage lombaire
- Porte-document au dos
- Base plane
- Fixations pour ceinture de sécurité
- Embase pivotante 6°-12°-20°

Technical data :

- Grey velvet
- Adjustable backrest extension
- 110 mm pneumatic suspension
- Adjustable height (85 mm)
- Weight adjustment (max. 150 kg)
- Slide rails adjustment (190 mm)
- Fully foldable backrest with 32° tilt adj.
- Mechanical lumbar adj.
- Carry document in back
- Flat mounting plate
- Seat belt fixation points
- Turn table 6°-12°-20°

Options

- 61/834-12: Accoudoirs réglables
Adjustable armrests

Voir aussi notre catalogue sièges / You can see our seats catalogue

**VITRERIE
GLASS**

MULTI FARMER 30-6 CLASSIQUE, 30-6 TOP

ARRIÈRE SUPÉRIEURE / UPPER REAR

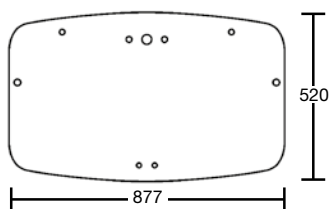

42/4072-55
(M045750)

TOIT / ROOF LAMP

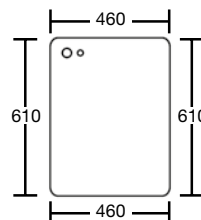

42/4005-1
(M045749)

LATÉRALE GAUCHE / LEFT SIDE

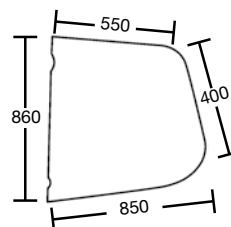

42/4043-5
(M045170)

PORTE / DOOR

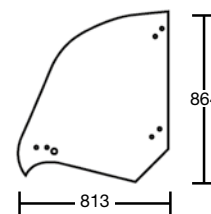

42/4030-8
(053691, 045171)

PARE BRISE / WINDSCREEN

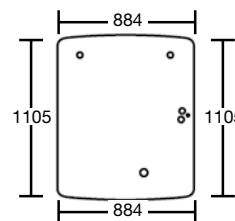

42/4001-33
(049497, 045748)

ARRIÈRE INFÉRIEURE / LOWER REAR

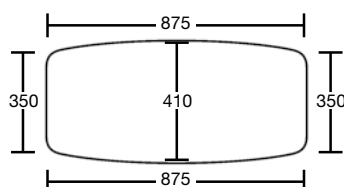

42/4045-5
(M045167)

LATÉRALE / SIDE

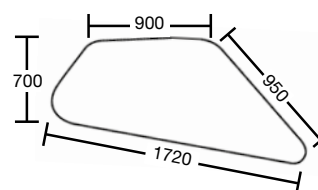

42/4032-9
(M045169,
049493)



**VITRERIE
GLASS**

Modèles EV models

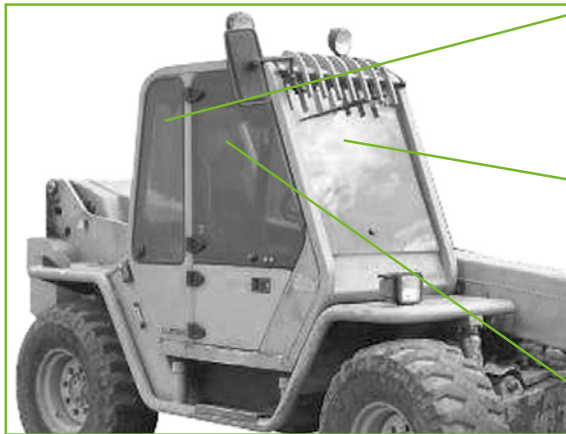

LATÉRALE / SIDE

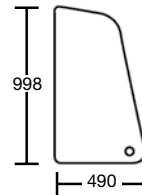

42/4030-9
(044166, 034916)

PARE BRISE / WINDSCREEN

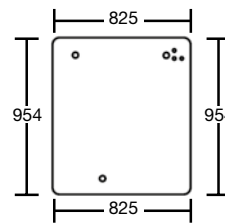

42/4001-34
(044164, 021592)

PORTE / DOOR

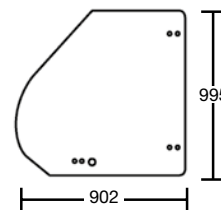

42/4045-6
(053944, 034915)

Modèles KT models

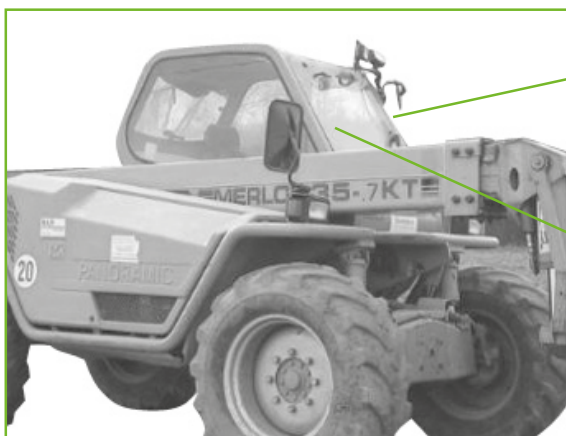

PORTE / DOOR

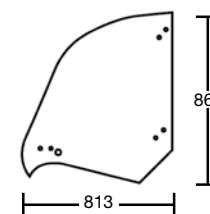

42/4030-8
(053691, 045171)

PARE BRISE / WINDSCREEN

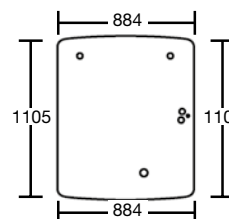

42/4001-33
(049497, 045748)

RÉFÉRENCES INTERCHANGEABLES
CROSS REFERENCES

OEM OEM	Réf. Ref.	Page Page	OEM OEM	Réf. Ref.	Page Page	OEM OEM	Réf. Ref.	Page Page	OEM OEM	Réf. Ref.	Page Page
01174421	60/97-39	9, 11	D00053	60/97-39	9, 11	M035367	42/958-43	14	M802917	42/497-224	16
01174423	60/111-56	9, 11	D00079	42/144-386	8	M035498	42/412-13	15	ML034660	42/7616-9	18
01179474	42/144-387	8	D00080	42/144-387	8	M035576	42/189-43	12	P00139	63/950-93	14
01180597	60/111-56	9, 11	M011456BA	42/775-14	18	M035577	42/189-42	12	P00274	60/161-38	9, 11
01180848	42/144-386	8	M013525AA	42/7801-1	15	M035578	42/1912-141	13	P00275	60/162-113	9, 11
015133AA	42/411-33	15	M014642	42/189-43	12	M036397	60/657-8	10, 11	P00503	60/161-38	9, 11
021592	42/4001-34	28	M014643	42/189-42	12	M036505	42/775-8	18	P00504	60/161-60	9, 11
024263	42/870-106	24	M014652K	42/410-65	15	M036548	42/7611-16	18	P00506	60/162-113	9, 11
024958 + 024986 + 034483	42/6450-76	17	M015401	42/1919-80	12	M036947	42/585-46	16	P00507	60/162-25	9, 11
027012 + 036484	42/6450-75	17	M016561	60/641-25	10, 11	M037025	42/1912-35	13	P00518	60/111-3	9, 11
027012 + 036484	42/6450-75	17	M018223	60/655-17	10, 11	M037026	42/1912-34	13	P00690	60/111-176	9, 11
02931168	60/104-4	11	M020074	42/1918-83	12	M037027	42/189-22	12	P00691	60/97-100	9, 11
029368	42/705-5	18	M020074	42/1918-83	12	M037028	42/189-23	12	U5MWW0092	42/130-248	6
029412	42/704-24	18	M020075	42/1918-84	12	M037605	42/962-57	14	U5MWW0104	42/130-214	6
030448	42/705-4	18	M020075	42/1918-84	12	M037825	42/962-55	14	U5MWW0157	42/130-248	6
033916	42/704-23	18	M021192	42/4090-8	24	M037826	42/962-56	14	U5MWW0159	42/130-193	6
034915	42/4045-6	28	M021590	42/420-11	15	M037828	42/962-53	15	U5MWW0160	42/130-193	6
034916	42/4030-9	28	M021841	42/1985-11	23	M037847	42/958-45	24	U5MWW0178	42/130-194	6
036489	42/704-22	18	M021842	42/1987-26	23	M037848	42/958-46	15	U5MWW0189	42/130-194	6
042814	42/189-24	12	M022433	42/1985-12	23	M039681	42/495-168	15	U5MWW0192	42/130-194	6
042815	42/189-25	12	M022683	42/1980-61	23	M040061	42/495-169	16	ULPK0005	42/100-93	6
04384102	60/161-45	9, 11	M022684	42/1980-62	23	M040640	82/4200-28	11	ULPK0034	42/100-93	6
044164	42/4001-34	28	M022919	42/775-15	18	M040660	82/9202-426	22	ULPR0005	42/101-17	6
044166	42/4030-9	28	M023040	42/775-11	18	M041918	63/1931-27	13			
045171	42/4030-8	27, 28	M024409	42/490-4	16	M042194	42/412-12	15			
045748	42/4001-33	27, 28	M024972	42/6403-35	17	M042848	70/4172-62	25			
049493	42/4032-9	27	M025964	42/412-14	15	M042970	42/412-11	15			
049497	42/4001-33	27, 28	M025964	42/412-14	15	M042994	42/412-11	15			
053691	42/4030-8	27, 28	M0261832	42/1987-26	23	M044196	42/105-40	19			
053944	42/4045-6	28	M026253	60/240-82	10, 11	M045167	42/4045-5	27			
1180596	60/111-96	9, 11	M026449	42/1924-1	12	M045169	42/4032-9	27			
2485C025	42/143-88	7	M026611	60/657-3	10, 11	M045170	42/4043-5	27			
2485613	42/143-43	7	M027045	42/171-7	19	M045714	42/1987-23	23			
2614B668	42/144-385	8	M027091	42/775-9	18	M045715	42/1980-60	23			
2644A002	60/97-100	9, 11	M028173	42/497-169	16	M045716	42/1985-10	23			
2654403	60/97-2	9, 11	M028948	82/4200-50	11	M045718	42/1980-59	23			
2654A002	60/97-176	9, 11	M029128	42/7611-15	18	M045719	42/1985-9	23			
26560017	60/111-5	9, 11	M029262	42/775-8	18	M045720	42/1987-21	15			
26560201	60/111-176	9, 11	M029403	42/775-7	18	M045746	82/4200-37	11			
2666108	42/60-24	6	M029404	42/775-9	18	M045749	42/4005-1	27			
2873A101	62/930-80	21	M030030	42/154-194	7	M045750	42/4072-55	27			
2873A102	62/930-38	21	M031399	42/775-10	18	M046338	42/410-66	15			
2873A103	62/930-80	21	M031860	42/7611-17	18	M046581	42/144-388	22			
2873A107	62/930-80	21	M032128	42/7611-14	18	M046738	42/490-1	16			
2873B056	62/930-38	21	M032320	60/240-81	10, 11	M046740	42/490-2	16			
2873B071	62/930-38	21	M032327	42/150-159	7	M046917	42/412-14	15			
2873B072	62/930-5	21	M032487	42/1987-24	23	M047254	82/9202-194	22			
2873K404	62/930-181	21	M032492	42/962-54	14	M047378K	42/7801-2	15			
3M01586	60/111-56	9, 11	M032494	42/4170-68	24	M047499	42/6403-97	17			
42077	42/6417-11	17	M032495	42/4170-138	24	M047916	42/4090-6	24			
44266	42/411-34	15	M032591	82/9202-951	20	M047956	42/4090-7	24			
71420400	62/920-108	20	M032621	42/108-75	22	M048084	42/870-105	24			
D0054	60/104-4	11	M032887	70/4172-52	24	M048541	42/108-74	22			
D00032	60/162-119	9, 11	M032888	70/4172-54	24	M049504	60/161-203	9, 11			
D00033	60/161-45	9, 11	M032904	63/1921-1	13	M049505	60/162-203	9, 11			
D00043	60/161-176	9, 11	M032934	42/153-194	7	M049614	42/412-13	15			
D00044	60/162-176	9, 11	M032993	42/1912-141	13	M051480	82/4200-131	22			
			M034189	42/4170-137	24	M802542	42/495-269	16			

INDEX DES RÉFÉRENCES REFERENCE INDEX

OEM OEM	Page Page	OEM OEM	Page Page	OEM OEM	Page Page	OEM OEM	Page Page
42/60-24	.6	42/775-15	.18	60/97-176	.9, 11	82/4200-28	.11
42/100-93	.6	42/870-105	.24	60/104-4	.11	82/4200-37	.11
42/101-17	.6	42/870-106	.24	60/111-176	.9, 11	82/4200-50	.11
42/105-40	.19	42/958-43	.14	60/111-3	.9, 11	82/4200-131	.22
42/108-74	.22	42/958-45	.14	60/111-4	.9, 11	82/9202-194	.22
42/108-75	.22	42/958-46	.14	60/111-5	.9, 11	82/9202-426	.22
42/130-193	.6	42/962-53	.14	60/111-56	.9, 11	82/9202-951	.20
42/130-194	.6	42/962-54	.14	60/111-96	.9, 11		
42/130-214	.6	42/962-55	.14	60/161-38	.9, 11		
42/130-248	.6	42/962-56	.14	60/161-45	.9, 11		
42/143-43	.7	42/962-57	.14	60/161-60	.9, 11		
42/143-88	.7	42/1912-34	.13	60/161-176	.9, 11		
42/144-385	.8	42/1912-35	.13	60/161-203	.9, 11		
42/144-386	.8	42/1912-141	.13	60/162-113	.9, 11		
42/144-387	.8	42/1913-136	.13	60/162-119	.9, 11		
42/144-388	.22	42/1918-83	.12	60/162-176	.9, 11		
42/150-159	.7	42/1918-84	.12	60/162-203	.9, 11		
42/150-164	.7	42/1919-80	.12	60/162-25	.9, 11		
42/150-163	.7	42/1919-81	.12	60/240-81	.10, 11		
42/153-194	.7	42/1924-1	.12	60/240-82	.10, 11		
42/154-194	.7	42/1931-19	.13	60/641-25	.10, 11		
42/171-7	.19	42/1980-59	.23	60/655-17	.10, 11		
42/189-22	.12	42/1980-60	.23	60/657-3	.10, 11		
42/189-23	.12	42/1980-61	.23	60/657-8	.10, 11		
42/189-24	.12	42/1980-62	.23	61/830-933	.25		
42/189-25	.12	42/1985-9	.23	61/830-938	.26		
42/189-42	.12	42/1985-10	.23	61/830-939	.26		
42/189-43	.12	42/1985-11	.23	61/833-2	.25		
42/410-65	.15	42/1985-12	.23	61/833-4	.25		
42/410-66	.15	42/1987-21	.23	62/920-101	.20		
42/411-33	.15	42/1987-23	.23	62/920-102	.20		
42/411-34	.15	42/1987-24	.23	62/920-108	.20		
42/412-11	.15	42/1987-26	.23	62/920-152KT	.20		
42/412-12	.15	42/4001-33	.27, 28	62/930-5	.21		
42/412-13	.15	42/4001-34	.28	62/930-38	.21		
42/412-14	.15	42/4005-1	.27	62/930-80	.21		
42/420-11	.15	42/4030-8	.27, 28	62/930-181	.21		
42/490-1	.16	42/4030-9	.28	62/930-185	.21		
42/490-2	.16	42/4032-9	.27	62/930-200	.21		
42/490-4	.16	42/4043-5	.27	62/930-205	.21		
42/495-168	.16	42/4045-5	.27	62/930-223	.21		
42/495-169	.16	42/4045-6	.28	63/950-93	.14		
42/495-269	.16	42/4072-55	.27	63/1921-1	.13		
42/497-169	.16	42/4090-6	.24	63/1931-27	.13		
42/497-224	.16	42/4090-7	.24	63/1955-472	.12		
42/566-300	.19	42/4090-8	.24	63/1995-5	.13		
42/566-301	.19	42/4170-68	.24	64/3102-411	.25		
42/566-302	.19	42/4170-137	.24	64/3102-412	.25		
42/566-303	.19	42/4170-138	.24	64/3102-413	.25		
42/566-304	.19	42/6403-35	.17	69/9410-20	.19		
42/566-305	.19	42/6403-97	.17	70/4172-52	.24		
42/566-355	.19	42/6417-11	.17	70/4172-53	.24		
42/585-46	.16	42/6450-75	.17	70/4172-54	.24		
42/704-22	.18	42/6450-76	.17	70/4172-62	.24		
42/704-23	.18	42/7611-14	.18	70/tub 1220	.8		
42/704-24	.18	42/7611-15	.18	70/tub 1225	.8		
42/705-7	.18	42/7611-16	.18	70/tub 1231	.8		
42/705-8	.18	42/7611-17	.18	70/tub 1233	.8		
42/775-9	.18	42/7616-9	.18	70/tub 1237	.8		
42/775-10	.18	42/7801-1	.15	70/tub 1244	.8		
42/775-11	.18	42/7801-2	.15	70/tub 1248	.8		
42/775-12	.18	60/97-2	.9, 11	70/tub 1255	.8		
42/775-13	.18	60/97-39	.9, 11	70/tub 1265	.8		
42/775-14	.18	60/97-100	.9, 11	70/tub 1280	.8		

**BEPCO PARTS SA****HERMALLE-SOUS-HUY**

Rue Chaumont, 4D • 4480 Hermalle-sous-Huy • Belgique
T +32 85 24 54 00 • F +32 85 24 54 50
info.be@bepcoparts.com • www.bepcoparts.com

VILLERS-LE-BOUILLET

Rue de Waremme, 114 • 4530 Villers-le-Bouillet • Belgique
T +32 85 24 54 00 • F +32 85 24 54 50
info.be@bepcoparts.com • www.bepcoparts.com

**BEPCO UK LTD**

Bepco House • Unit 316 • Hartlebury Trading Estate
Hartlebury - Worcestershire, DY10 4JB (UK)
P +44 (0)1299 252270 • F 0800 216553
info@bepcoparts.com • www.bepcoparts.com

**BEPCO FRANCE SAS**

Z.I. La Plaine, Allée de Bigorre
BP80041 Le Passage • 47901 Agen Cedex 9 • France
T +33 (0)553 96 31 25 • F +33 (0)553 68 03 72
info.fr@bepcoparts.com • www.bepcoparts.com

VILLENEUVE-SUR-LOT

294 Av. de Bordeaux • CS 30059 Bias
FR-47302 Villeneuve sur lot • France
T +33 (0)5 53 40 37 50 • F +33 (0)5 53 70 61 93

JANZÉ

P.A. de la Chauvelière • Rue Charles Lindbergh
35150 JANZE • France
T + 33 (0)2 99 44 16 18 • F +33 (0)2 99 44 17 29

**TVH AUSTRALASIA PTY LTD**

HEAD OFFICE BRISBANE • www.bepcoparts.com

ADELAIDE

96 South Terrace • Wingfield SA 5013
Free 1800 182 344 • T +61 8 8359 8933 • F +61 8 8234 2212
BepcoSAsales@tvh.com.au

BRISBANE

735 Boundary Road • Richlands QLD 4077
Free 1800 020 082 • T +61 7 3344 1113 • F +61 7 3344 1332
BepcoQLDsales@tvh.com.au

MELBOURNE

7/66-74 Micro Circuit • Dandenong South VIC 3175
Free 1800 802 367 • T +61 3 9796 5422 • F +61 3 9796 5251
BepcoVICsales@tvh.com.au

PERTH

2/15 Colin Jamieson Drive • Welshpool WA 6106
Free 1800 182 344 • T +61 8 8352 8984 • F +61 8 8234 2212
BepcoWAsales@tvh.com.au

SYDNEY

1/1002-1010 Canley Vale Rd • Wetherill Park NSW 2164
Free 1800 808 827 • T +61 2 6885 5288 • F +61 3 9796 5251
BepcoNSWsales@tvh.com.au

**TVH NEW ZEALAND LTD****AUCKLAND**

PO Box 51490 • Pakuranga 2140 • 11K Echelon Place
East Tamaki • Auckland
Free 0800 459 662 • T +64 9 274 9695 • F +64 9 274 9698
info@tvh.co.nz • www.tvh.com

CHRISTCHURCH

11C Parkhouse Road
Wigram • Christchurch 8042
Free 0508 8 722 867 • T +64 3 550 1298 • F +64 3 974 9993
infochch@tvh.co.nz

**BEPCO DEUTSCHLAND GmbH**

Neuer Weg 5 • 59505 Bad Sassendorf • Germany
T +49 (0)2927 919 59 0 • F +49 (0)2927 919 59 59
info.de@bepcoparts.com • www.bepcoparts.com

**BEPCO NEDERLAND BV**

Den Dolvert 10 • 5473 GP, Heeswijk-Dinther • Nederland
T +31 (0)413 29 39 75 • F +31 (0)413 29 40 87
info.nl@bepcoparts.com • www.bepcoparts.com

**BEPCO IBÉRICA SA**

C/ Torrent de Vallmajor, 82
08915 Badalona (Barcelona) • Spain
T +34 (0)902 111 062 - 933 810 062 • F +34 (0)933 813 345
info.es@bepcoparts.com • www.bepcoparts.com

ALMENDRALEJO

Ctra. Badajoz - Pol. «Rayvaz» Nave 21
06200 Almendralejo (Badajoz)
T +34 (0)902 111 062 - 924 664 890
F +34 (0)924 664 576

DOS HERMANAS

Pol. Ind. La Isla, C/ Hornos, 11
41703 Dos Hermanas (Sevilla)
T +34 (0)902 111 062 - 954 931 546
F +34 (0)954 930 130

SANTIAGO DE COMPOSTELA

Pol. El Tambre, Via Faraday, 36
15890 Santiago de Compostela
T +34 (0)902 111 062 - 981 560 012
F +34 (0)981 557 753

**TVH PARTS SOUTH AFRICA (Pty) Ltd**

HEAD OFFICE JOHANNESBURG • www.tvh.com

CAPE TOWN

1 Karee Street • Kraaifontein Industries • Cape Town 7571
T +27 21 988 2432 • F +27 21 988 9127
capetownsales@tvh.com

DURBAN

2 Monaco Place • Westmead • Pinetown 3600
T +27 31 100 0760 • F +27 31 700 6191
durbansales@tvh.com

JOHANNESBURG

90 Electron Avenue • Isando • Kempton Park 1601
T +27 11 281 27 00 • F +011 974 9845
johannesburgsales@tvh.com

LICHTENBURG

Shop 1 • 109 Scholtz Street • Lichtenburg 2740
T +27 18 632 6192/6092 • F +27 18 632 6108
lichtenburgsales@tvh.com

PORT ELIZABETH

134 Kempston Road • Korsten • Port Elizabeth 6020
T +27 41 453 1404/8 • F +27 41 453 1409
portelizabethsales@tvh.com

FOR ALL OUR LATEST CATALOGUE UPDATES AND COMPANY INFO: WWW.BEPCOPARTS.COM



The spare parts mentioned in this list can normally be delivered from stock. In addition, we can supply parts, which are not mentioned in this catalogue, with the shortest possible delivery time. The O.E.M. references are only for indication purposes and do not imply that the spare parts are coming from the manufacturer. This spare parts list can be modified without prior notice. All photographs, drawings, illustrations, brand names, descriptions and numbers are included for identification purposes only.



De onderdelen vermeld in deze lijst, zijn normaal uit voorraad leverbaar, behoudens uitverkocht. Ook niet-vermelde onderdelen kunnen binnen de kortste tijd uitgeleverd worden. De O.E.M. referenties dienen enkel ter indicatie en impliceren niet dat deze van de vermelde constructeur afkomstig zijn. Deze onderdelenlijst kan zonder enige voorafgaande verwittiging aangepast worden. Alle gebruikte foto's, tekeningen, afbeeldingen, merknamen, omschrijvingen en nummers dienen alleen ter identificatie.



Les pièces de rechange, mentionnées dans cette liste, sont normalement livrables du stock. En plus, les articles non indiqués peuvent être fournis en peu de temps. Cette liste peut être modifiée sans avis préalable. Les références O.E.M. sont seulement indicatives et n'impliquent pas que les pièces de rechange viennent du constructeur. Toutes les photographies, illustrations, marques, descriptions, tous les plans et numéros servent exclusivement à une identification.



Die in dieser Liste aufgeführten Teile sind normalerweise aus dem Lager lieferbar. Wir sind zudem in der Lage nicht aufgeführte Teile innerhalb kürzester Zeit zu liefern. Die O.E.M. Referenznummern dienen zur Information und beinhalten nicht, dass diese vom genannten Hersteller kommen. Diese Bestandsliste kann ohne vorhergehende Ankündigung geändert werden. Alle verwendeten Foto's, Zeichnungen, Abbildungen, Markennamen, Beschreibungen und Nummern dienen nur zu Identifikationszwecken.



Los artículos mencionados en este catálogo se encuentran habitualmente en stock. Además, podemos suministrar en un plazo corto de tiempo otros artículos relacionados que no se encuentren expresamente mencionados en este catálogo. Las referencias O.E.M. sirven sólo como indicación y no implican que procedan del constructor. Este listado de productos puede estar sujeto a modificaciones sin aviso previo. Todas las fotos, dibujos, ilustraciones, nombres de marca, descripciones y números se han incluido simplemente con el propósito de su identificación.



I pezzi di ricambio, menzionati in questo listino, possono essere forniti con una consegna immediata a condizione che non siano esauriti. I pezzi di ricambio non menzionati possono essere forniti in poco tempo. Le referenze O.E.M. sono solamente indicative e non implicano che i pezzi di ricambio vengano da questo costruttore. Questa lista ricambi può essere aggiustata senza avvisi anticipati. Tutti i numeri, codici, nomi, foto, spaccati e disegni sono solo a titolo informativo.



Części z tego katalogu są zazwyczaj na stanie magazynowym. Również części które nie są wyszczególnione w katalogu mogą być dostarczone na zamówienie w najkrótszym możliwym terminie. Opis części O.E.M. jest używany informacyjnie i nie wskazuje na to, że dany produkt jest wyprodukowany przez podanego producenta. Zawartość katalogu może ulec zmianie bez wcześniejszego informowania o tym. Wszystkie użyte zdjęcia, rysunki, nazwy marek, opis i numery służą tylko do identyfikacji.



Запчасти из настоящего списка, как правило, имеются в запасе, если только он не распродан. Прочие, не фигурирующие в списке артикулы, могут быть поставлены в самые кратчайшие сроки. Указание оригинальных номеров производителя не предполагает обязательного оригинального происхождения самих деталей. Данный список может изменяться без предварительного уведомления. Все использованные фото, рисунки, иллюстрации, названия брендов, наименования и номера служат исключительно для цели идентификации.

Visitez notre site :
www.bepcoparts.com

© **bepco 2016**

Tous droits réservés. Aucune partie de ce catalogue ne peut, ni intégralement, ni partiellement être reproduite ou communiquée (copiée, sauvegardée, utilisée dans un système de sauvegarde de données, etc) sous n'importe quelle forme, soit numérique ou mécanique, sans accord préalable et explicite de la société BEPCO PARTS.

- BEPCO est un fournisseur de pièces de rechange et accessoires d'après-vente qui sont appropriés pour l'entretien et la réparation des équipements OEM. Les Références OEM et marques sont à titre purement indicatif et ne signifient pas que les accessoires et/ou pièces de rechange viennent du fabricant de l'équipement ou des pièces d'origine.
- Les produits qui ne sont pas conformes aux exigences réglementaires concernant la conformité de la CE ne sont pas mis sur le marché dans l'Espace économique européen.
- BEPCO® est une marque déposée.
- Toutes les ventes sont soumises aux termes et conditions générales de vente sur www.bepcoparts.com
- Les photographies et les illustrations sont inclus à titre de référence seulement. Sous réserve d'erreurs d'impression.

Visit us on the Internet:
www.bepcoparts.com

© **bepco** 2016

All rights reserved. No part of this catalogue may be reproduced or communicated in any form or by any means, electronic or mechanical, including copying, recording or use in an information storage or retrieval system, without prior and explicit permission of BEPCO PARTS.

- BEPCO is a supplier of after-market spare parts and accessories that are suitable for the maintenance and repair of OEM-equipment. OEM references and brands are purely indicative and do not imply that the accessories and/or spare parts are coming from the original equipment or parts manufacturer.
- Products that do not comply with regulatory requirements concerning CE conformity are not placed on the market in the European Economic Area.
- BEPCO® are registered trademarks.
- All sales are subject to the general terms & conditions of sale on www.bepcoparts.com
- Photographs and illustrations are included for reference purposes only. Printing errors reserved.

Case IH
David Brown
Fendt
Fiat
Ford
Hürlimann
JCB
John Deere
K.H.D. (Deutz)
Kubota
Landini
Lamborghini
Manitou
Massey Ferguson
Mc Cormick

Pièces détachées
de A à Z
toutes marques

Spare parts
from A-Z for
all brands

Merlo

New Holland
Renault
Same
Steyr
Valmet
Zetor

moving forward in every field

REF. 90/999-275